

SEARCH PATH

Felix Meier

ABSTRACT: Distance and direction information on the display of an avalanche transceiver operating in search mode depend on the incident field lines of the magnetic field that is produced by a buried transceiver. The two of them determine the path that a user will walk when doing a search. The search path is usually not a straight line towards the location of the buried transceiver, but may take an unexpected detour. The SearchPath program can be used to simulate search paths depending on many parameters such as different snow and soil layers, burial depth, buried transceiver orientation, searching transceiver elevation above the snow surface, number of antennas in the searching transceiver. The tool is useful for personal investigations/studies, designing challenging training scenarios, preparing graphics for documentation and manuals and for developing new (better?) transceivers.

KEYWORDS: Avalanche Transceiver, Field Lines, Search Path, FDTD.

1 Introduction

The use of transceivers has become commonplace for all persons who move in avalanche terrain. At first sight, they are expected to lead a searching person to the location of a buried person on a straight line. Unfortunately, this is only the case in a very particular situation. In most cases, the search path taken when following the indications on the transceiver's display will be quite different from a straight line.

We will first provide the basic theory on how the distance and direction indications on a searching transceiver are derived by evaluating the incident magnetic field that is produced by the buried transceiver.

In the following section, we will show how the incident magnetic field at the searching transceiver may be calculated depending on various parameters such as different snow and soil layers, burial depth, orientation of the

buried transceiver's antenna and the searching transceiver elevation above the snow surface.

We then give some examples of specific configurations. These examples will show some variants of the search path to be expected. Also, the examples will provide strong arguments for replacing transceivers with two antennas by newer models with three antennas.

2 Deriving Distance and Direction

We assume a Cartesian coordinate system. The x-axis is aligned with the long side of the receiving transceiver, the y-axis with the short side and the z-axis is normal to the plane of the front side surface of the transceiver. The three antennas inside the transceiver have their axis aligned with one of the coordinate axes each. The projections of the incident field vector onto each of the axes define the signal that is received by the corresponding antennas:

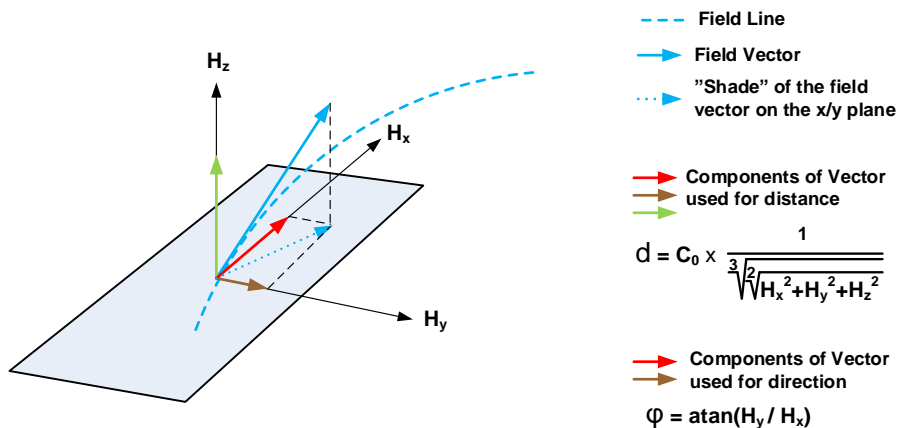

Fig. 1 Field Line and Vector

For estimating the distance, it is assumed that the transceivers operate in the near field region, i.e. at distances less than 105 meters. In that region, a good approximation is that the distance is inversely proportional to the third root of the strength of the incident magnetic field.

For an estimate of the direction, the arctangent of the H_y and H_x components of the field vector is taken. Note that if the field lines are next to perpendicular to the plane that is spanned by the y and x axes, the H_y and H_x components may become very small, thus resulting in erratic direction information.

3 Calculating the Field Vector

The magnetic field produced by the buried transceiver is equal to the magnetic field as produced by a dipole. It may be visualized by a multitude of doughnut shaped toroids:

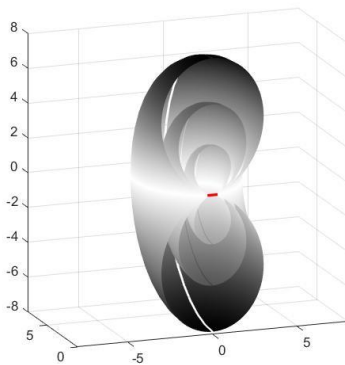

Fig. 2 Horizontal Antenna

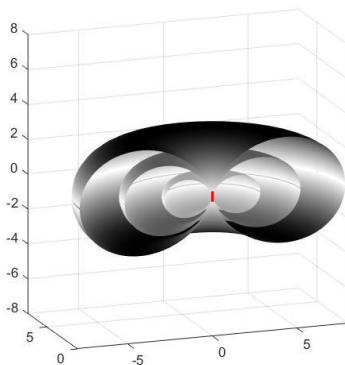

Fig. 3 Vertical Antenna

Note that the field lines exhibit rotational symmetry about the main axis of the dipole. The main axis is the axis of the antenna that is used for transmission. For reasons of efficiency, this

is usually the antenna that is aligned with the long side of the transceiver

In a homogenous space, there is a closed form solution for calculating the shape of the field lines given by McTavish [1]:

$$\frac{dy}{dx} = \frac{3 \cdot x \cdot y}{2 \cdot x^2 - y^2}$$

that resolves to

$$x^2 + y^2 = C \cdot y^{\frac{4}{3}}$$

If the dipole axis is aligned with the x axis.

Unfortunately, this straightforward approach does not apply to the avalanche site situation: the space around the buried transceiver and the searching transceiver is composed of several layers with different electromagnetic properties (permeability μ , permittivity ϵ , conductivity σ):

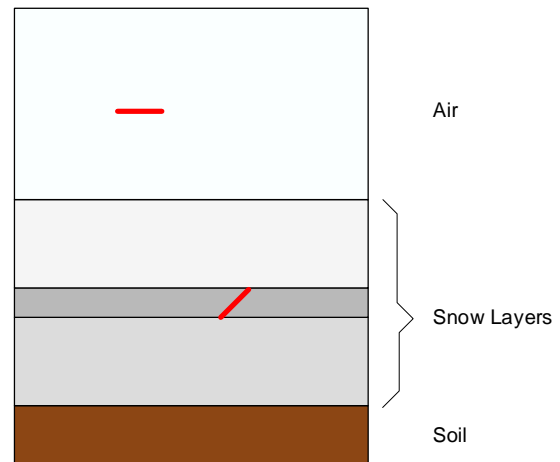

Fig. 4 Layers

For this configuration, there is no closed form solution to the problem of calculating the magnetic field components at every point in the space around the transceivers.

In its most general form, the electromagnetic field is defined by the fundamental equations given by Maxwell:

$$\frac{\partial \vec{E}}{\partial t} = -\frac{\sigma}{\epsilon} \vec{E} + \frac{1}{\epsilon} (\nabla \times \vec{H}) - \frac{1}{\epsilon} \vec{J}_s$$

$$\frac{\partial \vec{H}}{\partial t} = -\frac{\sigma_m}{\mu} \vec{H} - \frac{1}{\mu} (\nabla \times \vec{E}) - \frac{1}{\mu} \vec{J}_{ms}$$

Fortunately, the computing power that is available on today's personal computers allows for solving these equations by means stepwise numerical integration. For that purpose, the space of interest

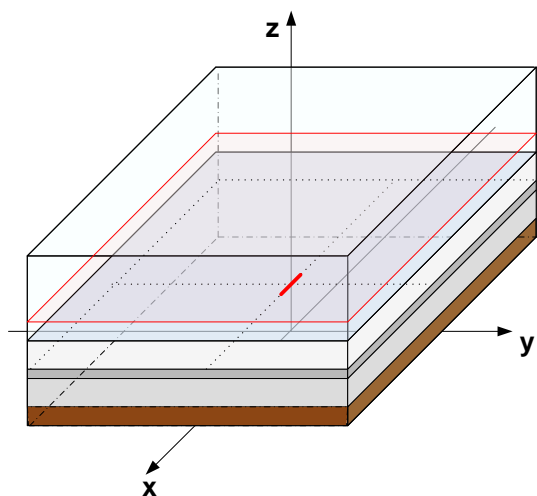

Fig. 5 The space of interest

is divided into a three dimensional grid of small cubic cells.

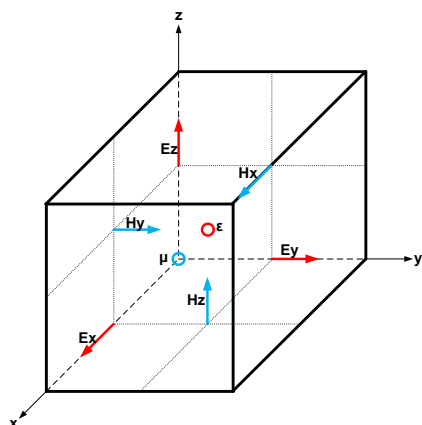

Fig. 6 A single cell

The evolution of the electromagnetic field within the entire space is then calculated by numerical integration for every one of these cells in many small time steps. This algorithm is called the FDTD (Finite Difference Time Domain) algorithm. It has originally been proposed by Yee [2] and is treated in detail by Taflove and Hagness [3].

As a result, the magnetic field vector at every location (cell) within the space of interest may be evaluated, and the local field strength (giving the distance to a buried transmitter) as well as the direction indication produced by a searching transceiver can be calculated.

4 The Computer Program

A program implementing the FDTD algorithm and running under the Microsoft Windows™ operating system has been prepared that provides a graphical user interface for investigating various configurations. The program is based on the following configuration of layers:

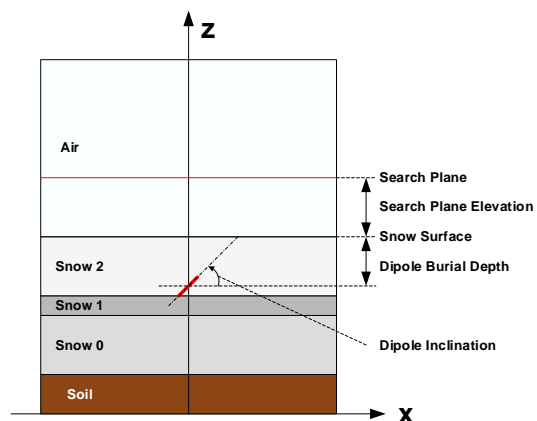

Fig. 7 The computer model

The searching transceiver is assumed to be aligned with the search plane. Many parameters may be specified by the user:

- Number of cells in each direction
- Size of the cells
- Search plane elevation above the snow surface
- Burial depth
- Buried antenna inclination
- Electromagnetic properties of the individual layers

The calculations for a typical configuration take less than one minute on a decent PC.

5 Examples

A horizontal buried transceiver buried at a depth of one meter produces the field as shown in figure 8 on a plane that is 80 centimeters above the snow surface. The red line is the search path that will be taken when following the direction information while the distance indication is decreasing. Note that the search path is not a straight line. Its shape depends very much on the location where the search is started. At a point when the x axis is reached, there may be a sharp turn.

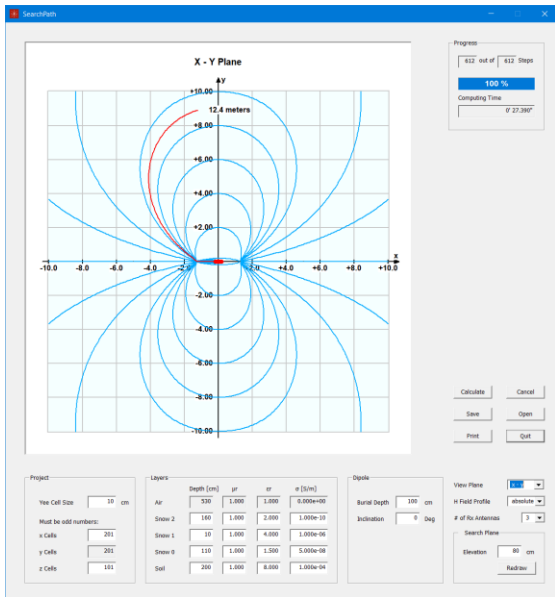

Fig. 8 Field lines in the search plane

A cross section that is spanned by the x and z axes looks like this:

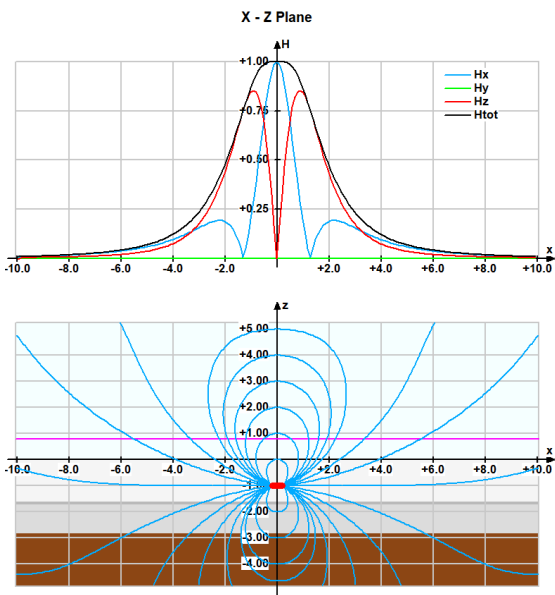

Fig. 9 x-z Cross section

At the point where the x axis is reached, the field lines are (almost) perpendicular to the search plane, so the H_y and H_x components will be very small. This may lead to erratic direction information on the display.

Also, the difference between having 2 or 3 antennas in the searching transceiver can be demonstrated:

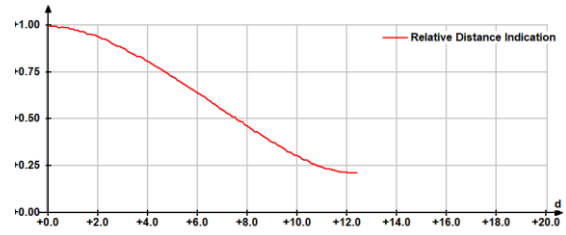

Fig. 10 Three antennas

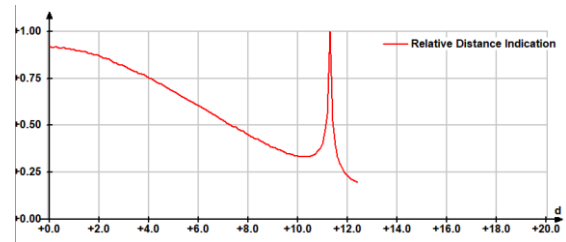

Fig. 11 Two antennas

On a two antenna transceiver, the distance indication at the critical point will increase considerably, contributing to even more confusion.

The ideal case for a search is when the antenna of the buried transceiver is oriented vertically:

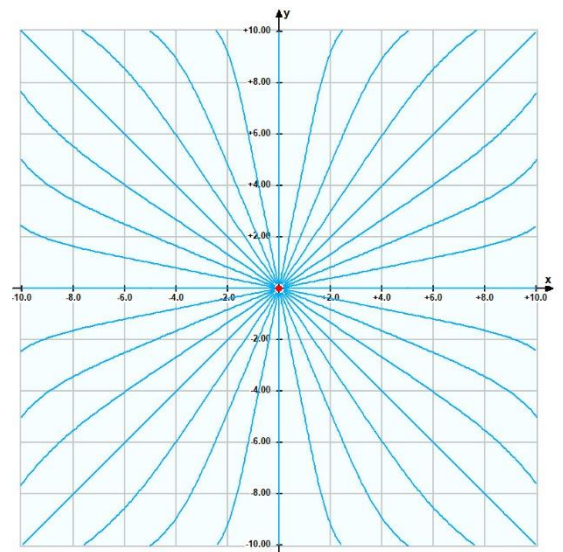

Fig. 12 Vertical transmitter

The direction indication on the searching transceiver will lead to the location of the buried transceiver in a straight line. (The deviations from a straight line near the boundaries of the space of interest are due to reflections at the boundaries that are very difficult to avoid).

Another interesting case is when the buried transceiver is inclined by 60 degrees:

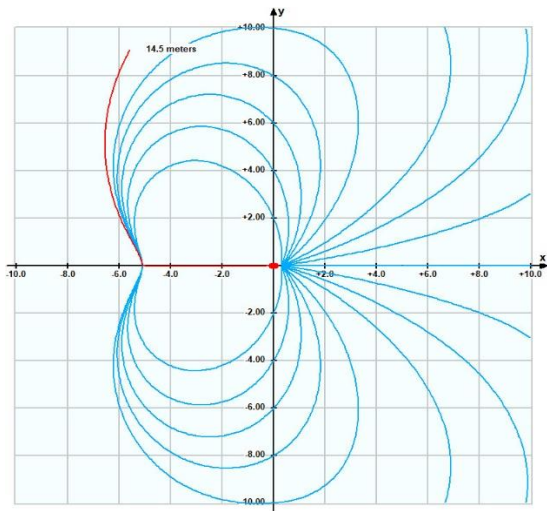

Fig. 13 60 deg inclined transmitter

At the point where the field lines are (almost) perpendicular to the search plane, there will be a turn of almost 90 degrees!

The search path that will be taken when following the direction by decreasing distance indication can be shown for any configuration by right-clicking anywhere in the x-y view plane display. The x-z view plane will then show a vertical cross section on the x-z plane and the relative distance indication to be expected when following the search path.

6 Download Sources

The program, the user manual and the technical documentation may be downloaded for free from

[https:// felmeier.com/en/software/SearchPath](https://felmeier.com/en/software/SearchPath)

or (German documentation)

[https:// felmeier.com/de/software/SearchPath](https://felmeier.com/de/software/SearchPath)

The tool is useful for personal investigations/studies, designing challenging training scenarios, preparing graphics for documentation and manuals and for developing new (better?) transceivers.

References:

- [1] Mc Tavish, J. P.; Field pattern of a magnetic dipole; [Am. J. Phys. Vol. 68, No. 6, June 2000; pg. 577-578]; Am. J. Phys. Vol. 69, No. 10, October 2001; pg. 1112

Mc Tavish, J. P.; Erratum: "Field pattern of a magnetic dipole"; Am. J. Phys. Vol. 68, No. 6, June 2000; pg. 577-578

- [2] Yee, K.S.; Numerical Solution of Initial Boundary Value Problems Involving Maxwell's Equations in Isotropic Media; IEEE Trans. On Antennas and Propagation, Vol. 14, No. 3, May 1966, pp. 302 - 307.

- [3] Taflove, A., Hagness, S. C., M. E.; Computational Electrodynamics, The Finite Difference Time Domain Method; 3rd Edition, Artech House Inc. 2005

About the Author:

The author can be reached at

Felix Meier
Roggenfarstrasse 32
CH – 8193 Eglisau
Switzerland

felix.meier.45@bluewin.ch